

Wheelscrews For Precision Internal Grinding

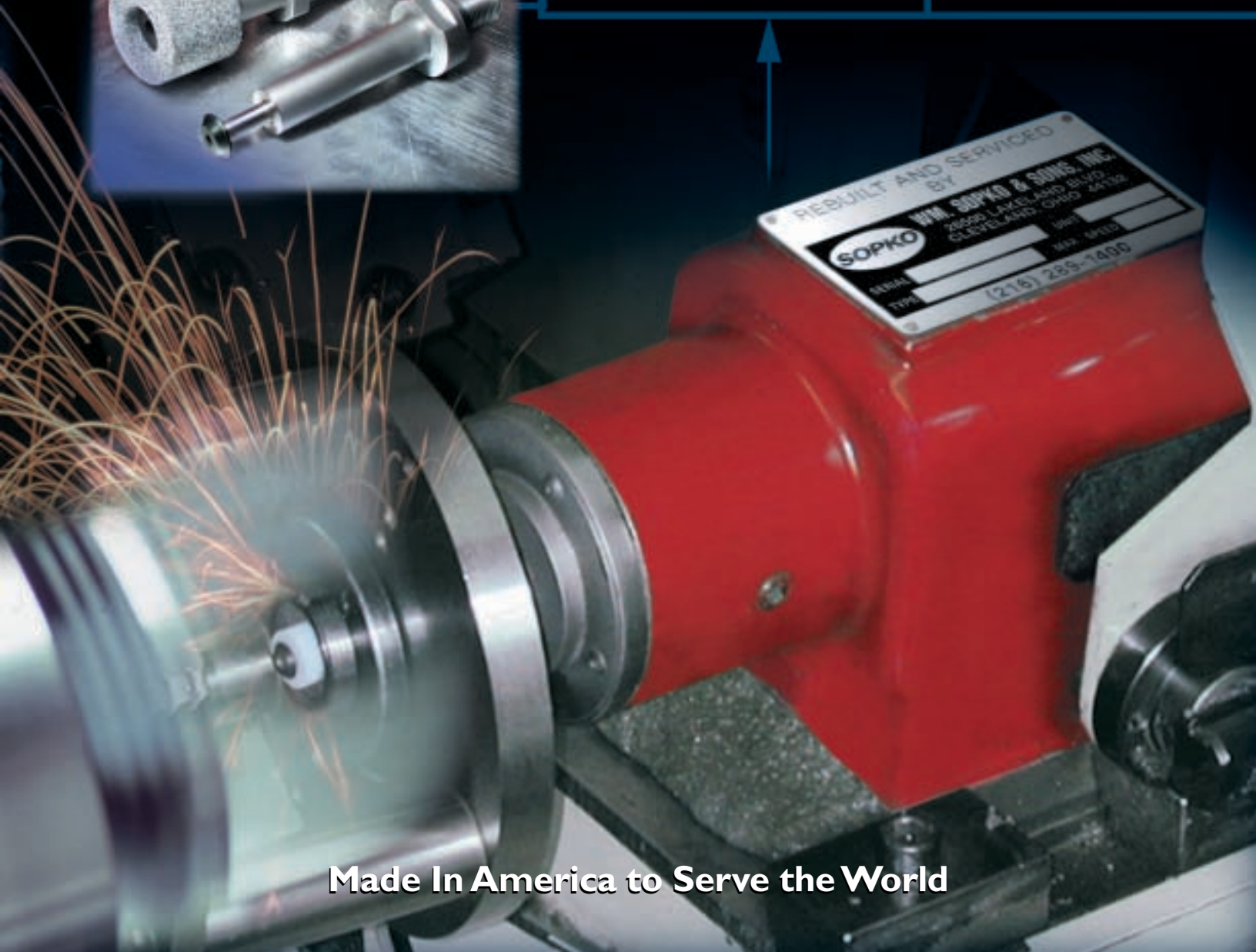

S



REBUILT AND SERVICED
BY
SOPKO W.W. SOPKO & SONS, INC.
2050 LAKELAND BLVD
CLEVELAND, OHIO 44130
SERIAL # _____
TYPE _____
MAX. RPM _____
(216) 285-1400

Made In America to Serve the World

Our Corporate History...

William Sopko & Sons Company began in a simple, personal way, much like many American corporations did. The company is still family owned and has made several expansions since it moved from its first "home".

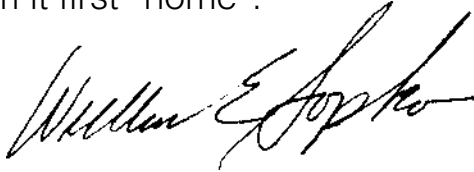

William Sopko, Jr.
reminisces:



William Sopko & Sons, Inc. was founded in 1952 by William and Mary Sopko. "Dad", known to his many friends as Willie, was the president and "Mom" was his secretary. There were no other employees. Located in the basement of our home in Euclid, Ohio, the company filled a need in the metal working industry by rebuilding all types of precision grinding spindles.

A year later, we began to manufacture spindle parts and accessories. Soon we introduced our line of grinding wheel adapters, quills, wheelscrews, and spindle accessories.

Mom passed away in 1967 and Dad passed away in 1974.

Then in 1976, company operations moved to a 12,000 square foot building in Wickliffe, Ohio, and on March 1, 1993 another move expanded operations into a 40,000 square foot building situated in Euclid, Ohio. It's from this location that we continue to operate in the tradition of founders, with the same dedication to manufacturing high quality products and providing reliable service at reasonable prices.

We have grown to become America's largest manufacturer and distributor of precision grinding wheel adapters, quills, wheelscrews, and spindle accessories; shipping nationwide and internationally to over 11,000 customers.

OUR CORPORATE GOALS...

We strive to provide quality products, competitive prices, and on-time delivery to all our customers, and to monitor our processes for continuous improvement.

OUR PLEDGE TO YOU...

Your orders for standard catalog items will be shipped with accuracy the day they are received by way of your designated delivery service. We will provide a knowledgeable staff to answer your technical questions, and we will only sell manufactured products of the highest quality at competitive prices.



The Sopko Difference...

SOPKO

When we began manufacturing wheelscrews, customers asked for an accessory that aided in producing top quality internal ground finishes and was safe to use.

PRECISION GROUND PILOT

Because Quality Finishes Matter.

The Sopko PRECISION GROUND PILOT centers the wheelscrew into your quill for true grinding wheel rotation, which results in top quality finishes. Since the pilot reduces the need for constant wheel dressing, your company saves time and money. Because the pilot supports the wheel and aligns perfectly into the quill, your machine operator is assured of a solid wheel mount – SAFETY FIRST!

EXTRA THIN HEAD DESIGN

Because Time Is Money.

Sopko EXTRA THIN HEAD DESIGN increases the life of your grinding wheels when face grinding and allows you to access those hard to reach blind holes. There is less need for costly counter boring in the workpiece and the quality of the finish is improved too!

CHOICE OF HEAD DIAMETERS

Because You Need Wheel Support.

To maximize the support of grinding wheels, the wheelscrew head diameter must match the quill diameter. Sopko provides the widest selection of head diameters in the industry. Variety means you have a CHOICE that assures equal clamping against the face of the quill for complete machine-operator safety.

HARDENED

Because You Expect Them to Last.

Sopko wheelscrews are made from alloy steel and fully heat-treated for service in tough industrial applications. We know you want performance and reliability.

SERVICE

Because You Can't Afford to Wait.

Orders placed by 2:30 P.M. ET, for standard items, are shipped that day. With rapid package delivery systems and our wheelscrew inventory depth, your needs can be filled in 24 hours!

VARIETY

Because You Want to Do It Right Every Time.

Making the right choice is easy with NEARLY 400 different Sopko wheelscrew sizes to select from. You can make the right choice for your particular application, first time, every time, and eliminate dangerous "make-do" methods for clamping grinding wheels.

Quality Wheelscrews Today...

BECAUSE WE'VE LISTENED!



For Safety's Sake...

DON'T USE ORDINARY SCREWS!

The correct mounting method illustrated below shows a wheel fully supported on the pilot of the wheelscrew. The remaining part of the pilot engages inside the quill. As a "rule-of-thumb", the wheel should be fully piloted and the quill engagement should be at least equal to the diameter of the wheelscrew.

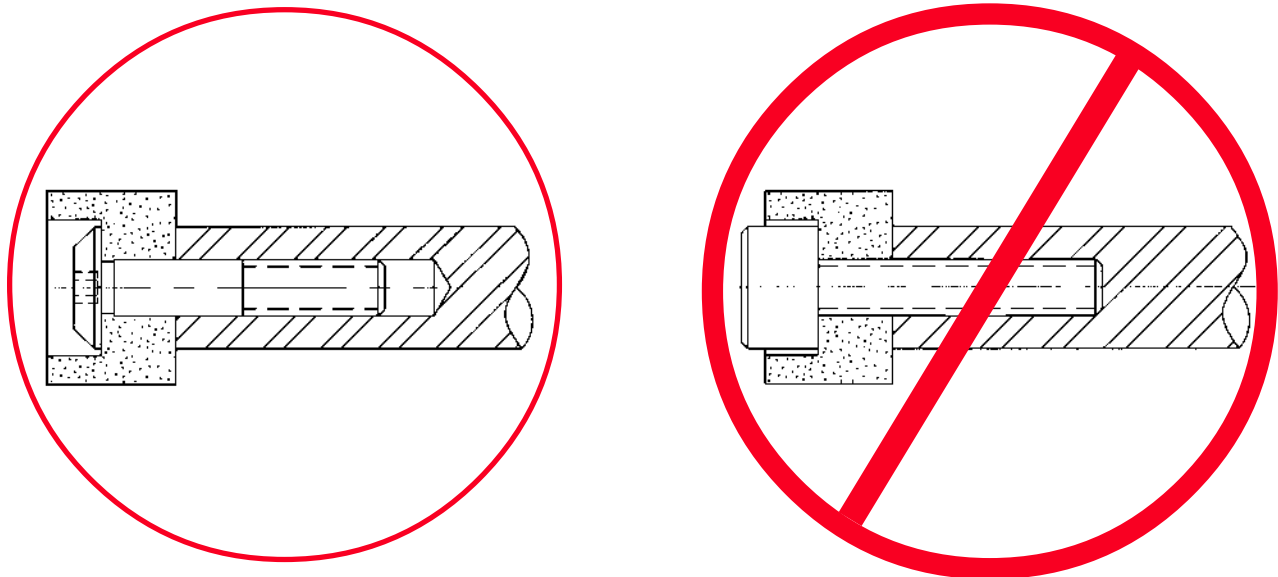

Check the Operator Benefit that Correct Wheel Mounting Provides!

- Assures **MAXIMUM SUPPORT** of the wheel load, reducing the risk of movement that could result in poor finish, loss of dimension and the need for re-dressing the wheel.
- **SAFER BY DESIGN** because the pilot eliminates the possibility of wheelscrew breakage, and since the wheel is fully supported, the chances of the wheel cracking or chipping are greatly reduced.
- **CONCENTRICITY IS MAINTAINED** when the proper wheelscrew pilot length engages inside the quill.

USE SOPKO PILOTED WHEELSCREWS!
USE SOPKO PILOTED QUILLS!

5-40RH THREAD SIZE WHEELSCREWS



America's Largest
Manufacturer of
Precision Grinding
Wheel Adapters.



43014

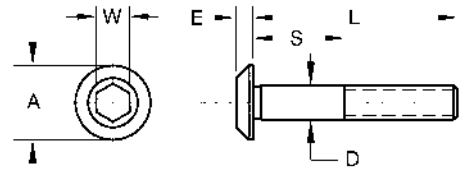

SOPKO CATALOG NO.	SOPKO PART NO.	L	S	D		A	E	W	HEALD PART NO.	BRYANT PART NO.
				MAX	MIN					
43000	0125-0.625	5/8	9/32	.125	.124	1/4	1/16	5/64	-	SC5100-1
43001	0125-0.625-1	5/8	5/16	.125	.124	1/4	1/16	5/64	-	-
43002	0125-0.625FH	5/8	9/32	.125	.124	7/16	1/16	5/64	-	-
43003	0125-0.750	3/4	13/32	.125	.124	1/4	1/16	5/64	-	SC5100-2
43004	0125-0.875	7/8	17/32	.125	.124	1/4	1/16	5/64	-	SC5100-3
43572	-	7/8	3/8	.125	.124	1/4	1/16	5/64	-	-
43005	0125-0.937	15/16	9/16	.125	.124	1/4	1/16	5/64	7-9416-006	-
43006	0125-0.937FH	15/16	9/16	.125	.124	5/16	1/16	5/64	7-9416-007	-
43007	0125-0.937-1	15/16	9/16	.125	.124	3/16	3/32	5/64	7-9416-005	-
43008	0125-0.937-2	15/16	1/4	.125	.124	1/4	1/16	5/64	-	-
43009	0125-1.000	1	1/2	.125	.124	1/4	1/16	5/64	7-9416-001	SC5100-4
43010	0125-1.000-2	1	1/2	.125	.124	3/16	3/32	5/64	7-9416	-
43011	0125-1.000FH	1	1/2	.125	.124	5/16	3/32	5/64	7-9416-003	-
43012	0125-1.062	1-1/16	1/2	.125	.124	1/4	1/16	5/64	-	-
43013	0125-1.125	1-1/8	11/16	.125	.124	1/4	1/16	5/64	7-9416-002	SC5100-5
43852	-	1-1/8	5/8	.125	.124	3/16	1/16	5/64	-	-
43014	0125-1.125FH	1-1/8	11/16	.125	.124	5/16	3/32	5/64	7-9416-004	-
43015	0125-1.250-1	1-1/4	1/2	.125	.124	1/4	1/16	5/64	-	-
43016	0125-1.250-2	1-1/4	3/4	.125	.124	1/4	1/16	5/64	-	-
43778	-	1-1/2	1	.125	.124	3/16	3/32	5/64	-	-
43017	0125-1.500	1-1/2	1	.125	.124	1/4	1/16	5/64	-	-

8-32RH THREAD SIZE WHEELSCREWS



43034

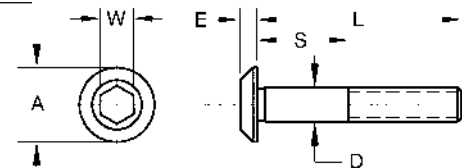

SOPKO CATALOG NO.	SOPKO PART NO.	L	S	D		A	E	W	HEALD PART NO.	BRYANT PART NO.
				MAX	MIN					
43018	1875-0.750	3/4	5/16	.1875	.1865	3/8	1/8	5/64	-	SC5101-1
43019	1875-0.875	7/8	7/16	.1875	.1865	3/8	1/8	5/64	-	SC5101-2
43020	1875-1.000	1	9/16	.1875	.1865	3/8	1/8	5/64	-	SC5101-3
43021	1875-1.000X	1	9/16	.1875	.1865	1/4	1/8	5/64	-	-
43022	1875-1.062	1-1/16	3/4	.1875	.1865	3/8	1/8	5/64	7-9417-002	-
43023	1875-1.125	1-1/8	11/16	.1875	.1865	3/8	1/8	5/64	-	SC5101-4
43024	1875-1.125-1	1-1/8	3/4	.1875	.1865	3/8	1/8	5/64	7-9417-003	-
43025	1875-1.250	1-1/4	5/8	.1875	.1865	3/8	1/8	5/64	7-9417	SC5101-5
43609	-	1-1/4	11/16	.1875	.1865	3/8	1/8	5/64	-	-
43026	1875-1.250-1	1-1/4	13/16	.1875	.1865	3/8	1/8	5/64	7-9417-004	-
43031	1875-1.500-3	1-1/2	1/2	.1875	.1865	3/8	1/8	5/64	-	-
43028	1875-1.500-1	1-1/2	3/4	.1875	.1865	3/8	1/8	5/64	-	-
43029	1875-1.500-2	1-1/2	7/8	.1875	.1865	3/8	1/8	5/64	7-9417-001	SC5101-6
43709	-	1-1/2	15/16	.1875	.1865	5/16	1/8	5/64	-	-
43033	1875-1.500-5X	1-1/2	1	.1875	.1865	5/16	1/8	5/64	-	-
43034	1875-1.750	1-3/4	1-1/8	.1875	.1865	3/8	1/8	5/64	-	SC5101-7
43771	-	1-3/4	1-3/16	.1875	.1865	3/8	1/8	5/64	-	-
43855	-	1-7/8	1-5/16	.1875	.1865	3/8	1/8	5/64	-	-

All photos shown actual size.

* Note: Sizes may not be combined to determine quantity price.



CAUTION!

Always Wear Safety Goggles When Grinding.

10-24RH THREAD SIZE WHEELSCREWS



America's Largest
Manufacturer of
Precision Grinding
Wheel Adapters.



43038

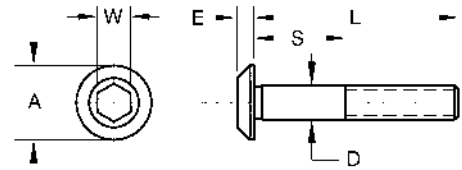

SOPKO CATALOG NO.	SOPKO PART NO.	L	S	D		A	E	W	HEALD PART NO.	BRYANT PART NO.
				MAX	MIN					
43036	1024-0.625	5/8	7/32	.1875	.1865	7/16	1/8	3/32	-	-
43037	1024-0.750	3/4	5/16	.1875	.1865	7/16	1/8	3/32	-	-
43038	1024-0.750FH	3/4	5/16	.1875	.1865	1/2	1/8	3/32	-	-

10-32RH THREAD SIZE WHEELSCREWS



43048

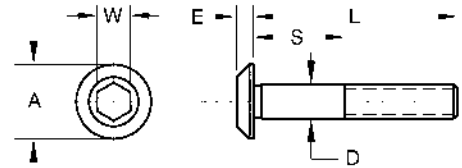

SOPKO CATALOG NO.	SOPKO PART NO.	L	S	D		A	E	W	HEALD PART NO.	BRYANT PART NO.
				MAX	MIN					
43039	1032-0.750	3/4	5/16	.1875	.1865	3/8	1/8	3/32	-	-
43884	-	7/8	5/16	.1875	.1865	1/2	1/8	3/32	-	-
43041	1032-0.875	7/8	7/16	.1875	.1865	3/8	1/8	3/32	-	-
43703	-	1-1/8	9/16	.1875	.1865	3/8	1/8	3/32	-	-
43752	-	1-3/8	13/16	.1875	.1865	3/8	1/8	3/32	-	-
43046	1032-1.500-4	1-1/2	7/16	.1875	.1865	3/8	1/8	3/32	-	-
43043	1032-1.500-1	1-1/2	3/4	.1875	.1865	3/8	1/8	3/32	-	-
43834	-	1-1/2	15/16	.1875	.1865	1/4	1/8	3/32	-	-
43908	-	1-1/2	15/16	.1875	.1865	3/8	1/8	3/32	-	-
43047	1032-1.625	1-5/8	1-3/16	.1875	.1865	3/8	1/8	3/32	-	-
43048	1032-1.625-1FH	1-5/8	1	.1875	.1865	1/2	1/8	3/32	-	-

All photos shown actual size.

* Note: Sizes may not be combined to determine quantity price.

CAUTION!
Always Wear Safety Goggles When Grinding.

1/4-20RH THREAD SIZE WHEELSCREWS



America's Largest
Manufacturer of
Precision Grinding
Wheel Adapters.



43080

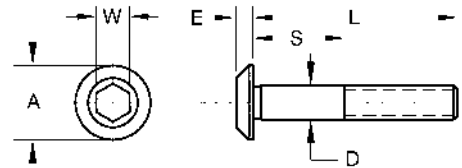

SOPKO CATALOG NO.	SOPKO PART NO.	L	S	D		A	E	W	HEALD PART NO.	BRYANT PART NO.
				MAX	MIN					
43049	0250-0.750-2FH	3/4	7/32	.250	.249	11/16	1/8	1/8	-	-
43050	0250-0.750-4FH	3/4	7/32	.250	.249	7/8	1/8	1/8	-	-
43051	0250-0.750-5FH	3/4	7/32	.250	.249	9/16	1/8	1/8	-	-
43052	0250-0.750-6FH	3/4	7/32	.250	.249	3/4	1/8	1/8	-	-
43053	0250-0.750-7FH	3/4	7/32	.250	.249	5/8	1/8	1/8	-	-
43054	0250-0.875	7/8	7/16	.250	.249	7/16	1/8	1/8	-	SC5102-1
43055	0250-0.937	15/16	5/16	.250	.249	7/16	1/8	1/8	-	-
43056	0250-0.937-1	15/16	1/2	.250	.249	7/16	1/8	1/8	-	-
43057	0250-0.937X	15/16	3/8	.250	.249	3/8	1/8	1/8	-	-
43712	-	1	3/8	.250	.249	3/8	1/8	1/8	-	-
43758	-	1	3/8	.250	.249	1/2	1/8	1/8	-	-
43059	0250-1.000-1X	1	1/2	.250	.249	3/8	1/8	1/8	856279	-
43058	0250-1.000	1	9/16	.250	.249	7/16	1/8	1/8	-	SC5102-2
43061	0250-1.062XX	1-1/16	11/16	.250	.249	0.346	1/8	1/8	-	-
43686	-	1-1/8	1/2	.250	.249	7/16	1/8	1/8	-	-
43800	-	1-1/8	1/2	.250	.249	1/2	1/8	1/8	-	-
43764	-	1-1/8	1/2	.250	.249	9/16	1/8	1/8	-	-
43766	-	1-1/8	1/2	.250	.249	5/8	1/8	1/8	-	-
43762	-	1-1/8	1/2	.250	.249	3/4	1/8	1/8	-	-
43062	0250-1.125	1-1/8	11/16	.250	.249	7/16	1/8	1/8	-	SC5102-3
43063	0250-1.125-1	1-1/8	5/8	.250	.249	7/16	1/8	1/8	-	-
43064	0250-1.130	1.13	0.73	.250	.249	0.325	1/8	1/8	-	-
43065	0250-1.187	1-3/16	7/8	.250	.249	7/16	1/8	1/8	7-9418-008	-
43066	0250-1.187-1XX	1-3/16	7/8	.250	.249	0.368	1/8	1/8	-	-
43067	0250-1.187-2XX	1-3/16	13/16	.250	.249	3/8	1/8	1/8	-	-
43068	0250-1.187-2X	1-3/16	13/16	.250	.249	0.368	1/8	1/8	-	T-74137
43874	-	1-1/4	5/8	.250	.249	3/8	1/8	1/8	-	-
43618	-	1-1/4	5/8	.250	.249	7/16	1/8	1/8	-	-
43069	0250-1.250	1-1/4	9/16	.250	.249	7/16	1/8	1/8	-	-
43618	-	1-1/4	5/8	.250	.249	7/16	1/8	1/8	-	-
43071	0250-1.312	1-5/16	7/8	.250	.249	7/16	1/8	1/8	-	SC5102-4
43072	0250-1.312X	1-5/16	3/4	.250	.249	3/8	1/8	1/8	-	-
43073	0250-1.312-1	1-5/16	1	.250	.249	7/16	1/8	1/8	-	-
43074	0250-1.312-1X	1-5/16	7/8	.250	.249	0.367	1/8	1/8	-	-
43075	0250-1.312-2FH	1-5/16	1	.250	.249	1/2	1/8	1/8	7-9418-012	-
43076	0250-1.312-3FH	1-5/16	1	.250	.249	9/16	1/8	1/8	7-9418-016	-
43077	0250-1.312-4FH	1-5/16	1	.250	.249	5/8	1/8	1/8	7-9418-020	-
43078	0250-1.340-1	1-11/32	1.09	.250	.249	7/16	1/8	1/8	-	-
43676	-	1-3/8	3/4	.250	.249	3/8	1/8	1/8	-	-
43747	-	1-3/8	3/4	.250	.249	7/16	1/8	1/8	-	-
43892	-	1-3/8	3/4	.250	.249	1/2	1/8	1/8	-	-
43765	-	1-3/8	3/4	.250	.249	5/8	1/8	1/8	-	-
43761	-	1-3/8	3/4	.250	.249	3/4	1/8	1/8	-	-
43080	0250-1.375-1	1-3/8	15/16	.250	.249	7/16	1/8	1/8	7-9418-009	-
43081	0250-1.437X	1-7/16	15/16	.250	.249	3/8	1/8	1/8	-	-

continued on page 6

All photos shown actual size.

* Note: Sizes may not be combined to determine quantity price.



CAUTION!

Always Wear Safety Goggles When Grinding.

1/4-20RH THREAD SIZE WHEELSCREWS



America's Largest
Manufacturer of
Precision Grinding
Wheel Adapters.



43105

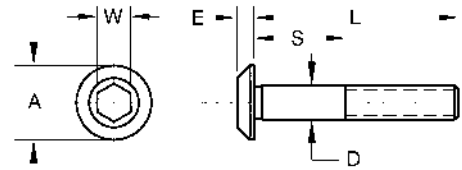

SOPKO CATALOG NO.	SOPKO PART NO.	L	S	D		A	E	W	HEALD PART NO.	BRYANT PART NO.
				MAX	MIN					
43085	0250-1.500-1	1-1/2	1/2	.250	.249	7/16	1/8	1/8	-	-
43801	-	1-1/2	7/8	.250	.249	3/4	1/8	1/8	-	-
43083	0250-1.500	1-1/2	11/16	.250	.249	7/16	1/8	1/8	-	SC5102-5
43748	-	1-1/2	7/8	.250	.249	7/16	1/8	1/8	-	-
43801	-	1-1/2	7/8	.250	.249	3/4	1/8	1/8	-	-
43082	0250-1.490-1	1-1/2	1-1/4	.250	.249	7/16	1/8	1/8	-	-
43088	0250-1.562	1-9/16	1-1/16	.250	.249	7/16	1/8	1/8	7-9418-010	-
43089	0250-1.562-1	1-9/16	13/16	.250	.249	7/16	1/8	1/8	-	-
43090	0250-1.562-1FH	1-9/16	1-1/16	.250	.249	1/2	1/8	1/8	7-9418-013	-
43091	0250-1.562-2FH	1-9/16	1-1/16	.250	.249	9/16	1/8	1/8	7-9418-017	-
43092	0250-1.562-3FH	1-9/16	1-1/16	.250	.249	5/8	1/8	1/8	7-9418-021	-
43093	0250-1.610-1	1.60	1.35	.250	.249	7/16	1/8	1/8	-	-
43791	-	1-5/8	1	.250	.249	3/8	1/8	1/8	-	-
43570	-	1-5/8	1	.250	.249	7/16	1/8	1/8	-	-
43549	-	1-5/8	1	.250	.249	1/2	1/8	1/8	-	-
43550	-	1-5/8	1	.250	.249	5/8	1/8	1/8	-	-
43094	0250-1.750FH	1-3/4	7/8	.250	.249	1/2	1/8	1/8	7-9418-002	-
43095	0250-1.750-1	1-3/4	3/4	.250	.249	7/16	1/8	1/8	-	SC5102-6
43096	0250-1.750-1FH	1-3/4	7/8	.250	.249	9/16	1/8	1/8	7-9418-004	-
43097	0250-1.750-2	1-3/4	7/8	.250	.249	7/16	1/8	1/8	7-9418	-
43098	0250-1.750-2FH	1-3/4	7/8	.250	.249	5/8	1/8	1/8	7-9418-006	-
43099	0250-1.750-3	1-3/4	15/16	.250	.249	7/16	1/8	1/8	-	SC5102-7
43100	0250-1.750-3FH	1-3/4	1-1/8	.250	.249	1/2	1/8	1/8	7-9418-014	-
43102	0250-1.750-4FH	1-3/4	1-1/8	.250	.249	9/16	1/8	1/8	7-9418-018	-
43103	0250-1.750-5FH	1-3/4	1-1/8	.250	.249	5/8	1/8	1/8	7-9418-022	-
43790	-	1-7/8	1-1/4	.250	.249	3/8	1/8	1/8	-	-
43104	0250-1.875	1-7/8	1-1/4	.250	.249	7/16	1/8	1/8	7-9418-011	-
43105	0250-1.875-1FH	1-7/8	1-1/4	.250	.249	1/2	1/8	1/8	7-9418-015	-
43106	0250-1.875-2FH	1-7/8	1-1/4	.250	.249	9/16	1/8	1/8	7-9418-019	-
43107	0250-1.875-3FH	1-7/8	1-1/4	.250	.249	5/8	1/8	1/8	7-9418-023	-
43108	0250-2.000	2	1-3/16	.250	.249	7/16	1/8	1/8	-	SC5102-8
43110	0250-2.125	2-1/8	1-1/4	.250	.249	7/16	1/8	1/8	7-9418-001	-
43111	0250-2.125-1	2-1/8	1-5/8	.250	.249	7/16	1/8	1/8	-	-
43112	0250-2.125-1FH	2-1/8	1-1/4	.250	.249	1/2	1/8	1/8	7-9418-003	-
43113	0250-2.125-2FH	2-1/8	1-1/4	.250	.249	9/16	1/8	1/8	7-9418-005	-
43114	0250-2.125-3FH	2-1/8	1-1/4	.250	.249	5/8	1/8	1/8	7-9418-007	-
43577	-	2-1/8	1-1/2	.250	.249	7/16	1/8	1/8	-	-
43890	-	2-1/8	1-1/2	.250	.249	1/2	1/8	1/8	-	-
43711	-	2-1/8	1-1/2	.250	.249	5/8	1/8	1/8	-	-
43115	0250-2.250	2-1/4	1-3/16	.250	.249	7/16	1/8	1/8	-	SC5102-9
43116	0250-2.250-1	2-1/4	1-3/4	.250	.249	7/16	1/8	1/8	-	-
43118	0250-2.500-1	2-1/2	1-7/8	.250	.249	7/16	1/8	1/8	-	-
43027	-	2-3/8	1-3/4	.250	.249	1/2	1/8	1/8	-	-
43978	-	2-3/8	1-3/4	.250	.249	5/8	1/8	1/8	-	-
43981	-	2-3/8	1-3/4	.250	.249	3/4	1/8	1/8	-	-

All photos shown actual size.

* Note: Sizes may not be combined to determine quantity price.

CAUTION!
Always Wear Safety Goggles When Grinding.



America's Largest
Manufacturer of
Precision Grinding
Wheel Adapters.

5/16-18RH THREAD SIZE WHEELSCREWS

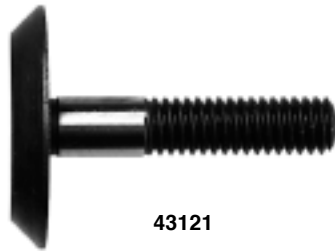

43121

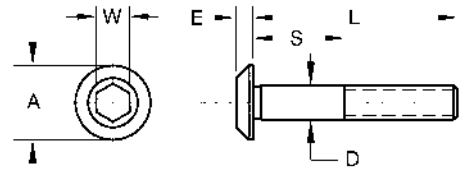

SOPKO CATALOG NO.	SOPKO PART NO.	L	S	D		A	E	W	HEALD PART NO.	BRYANT PART NO.
				MAX	MIN					
43119	0312-1.000FH	1	1/4	.3125	.3115	1	1/8	3/16	-	-
43120	0312-1.500-1	1-1/2	1/2	.3125	.3115	1/2	3/16	3/16	-	-
43121	0312-1.500-2FH	1-1/2	1/2	.3125	.3115	1-1/4	3/16	3/16	-	-
43122	0312-1.500-3FH	1-1/2	1/2	.3125	.3115	1-1/2	3/16	3/16	-	-
43818	-	1-3/8	11/16	.3125	.3115	1/2	3/16	3/16	-	-

3/8-16RH THREAD SIZE WHEELSCREWS



43190

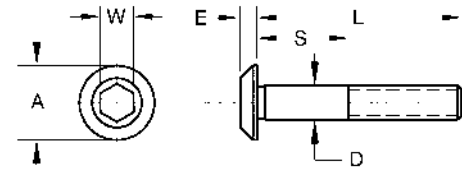

SOPKO CATALOG NO.	SOPKO PART NO.	L	S	D		A	E	W	HEALD PART NO.	BRYANT PART NO.
				MAX	MIN					
43175	0375B-.937X	15/16	0	.375	.374	9/16	1/8	3/16	-	-
43176	0375B-1.000	1	1/2	.375	.374	5/8	1/8	3/16	-	-
43178	0375B-1.250	1-1/4	1/2	.375	.374	5/8	1/8	3/16	-	-
43179	0375B-1.250FH	1-1/4	1/2	.375	.374	13/16	1/8	3/16	-	-
43964	-	1-1/4	1/2	.375	.374	1-1/4	1/8	3/16	-	-
43181	0375B-1.375-2	1-3/8	5/8	.375	.374	5/8	1/8	3/16	-	-
43631	-	1-1/2	3/4	.375	.374	5/8	1/8	3/16	-	-
43636	-	1-1/2	3/4	.375	.374	3/4	1/8	3/16	-	-
43560	-	1-5/8	7/8	.375	.374	5/8	1/8	3/16	-	-
43653	-	1-5/8	7/8	.375	.374	3/4	1/8	3/16	-	-
43662	-	1-5/8	7/8	.375	.374	1-1/4	1/8	3/16	-	-
43185	0375B-1.687	1-11/16	1/2	.375	.374	5/8	1/8	3/16	-	-
43187	0375B-1.750FH	1-3/4	7/8	.375	.374	1	1/8	3/16	-	-
43846	-	1-3/4	1	.375	.374	5/8	1/8	3/16	-	-
43500	-	1-7/8	1-1/8	.375	.374	5/8	1/8	3/16	-	-
43501	-	1-7/8	1-1/8	.375	.374	3/4	1/8	3/16	-	-
43502	-	1-7/8	1-1/8	.375	.374	7/8	1/8	3/16	-	-
43188	0375B-2.000	2	1-3/8	.375	.374	5/8	1/8	3/16	-	-
43675	-	2-1/8	1-3/8	.375	.374	5/8	1/8	3/16	-	-
43627	-	2-1/8	1-3/8	.375	.374	3/4	1/8	3/16	-	-
43189	0375B-2.375	2-3/8	1-3/8	.375	.374	5/8	1/8	3/16	-	-
43190	0375B-2.375FH	2-3/8	1-3/16	.375	.374	3/4	1/8	3/16	-	-
43191	0375B-2.375-1FH	2-3/8	1-3/8	.375	.374	1	1/8	3/16	-	-
43588	-	2-3/8	1-5/8	.375	.374	5/8	1/8	3/16	-	-
43856	-	2-3/8	1-5/8	.375	.374	7/8	1/8	3/16	-	-
43192	0375B-2.500	2-1/2	1-1/2	.375	.374	5/8	1/8	3/16	-	-
43763	-	2-7/8	2-1/8	.375	.374	5/8	1/8	3/16	-	-
43193	0375B-3.000	3	1-3/4	.375	.374	5/8	1/8	3/16	-	-
43579	-	3-1/8	2-3/8	.375	.374	5/8	1/8	3/16	-	-

All photos shown actual size.

* Note: Sizes may not be combined to determine quantity price.



CAUTION!

Always Wear Safety Goggles When Grinding.

3/8-20RH THREAD SIZE WHEELSCREWS



America's Largest
Manufacturer of
Precision Grinding
Wheel Adapters.



43153

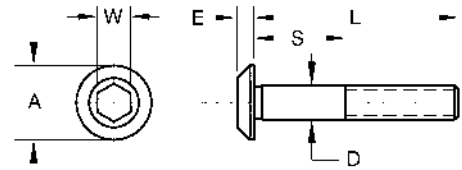

SOPKO CATALOG NO.	SOPKO PART NO.	L	S	D		A	E	W	HEALD PART NO.	BRYANT PART NO.
				MAX	MIN					
43123	0375A-1.000	1	1/2	.375	.374	5/8	1/8	3/16	-	-
43124	0375A-1.125FH	1-1/8	5/16	.375	.374	1	5/32	3/16	7-10208	-
43125	0375A-1.125-1FH	1-1/8	3/8	.375	.374	1-1/4	5/32	3/16	-	-
43126	0375A-1.187	1-3/16	5/8	.375	.374	5/8	1/8	3/16	-	SC5103-1
43885	-	1-1/4	1/2	.375	.374	1-1/4	1/8	3/16	-	-
43127	0375A-1.3125	1-5/16	3/4	.375	.374	5/8	1/8	3/16	-	SC5103-2
43888	-	1-3/8	5/8	.375	.374	9/16	1/8	3/16	-	-
43657	-	1-3/8	5/8	.375	.374	5/8	1/8	3/16	-	-
43616	-	1-3/8	5/8	.375	.374	3/4	1/8	3/16	-	-
43854	-	1-3/8	5/8	.375	.374	1-1/4	1/8	3/16	-	-
43129	0375A-1.4375	1-7/16	7/8	.375	.374	5/8	1/8	3/16	-	SC5103-3
43850	-	1-1/2	3/4	.375	.374	1/2	1/8	3/16	-	-
43646	-	1-1/2	3/4	.375	.374	3/4	1/8	3/16	-	-
43131	0375A-1.5625	1-9/16	1	.375	.374	5/8	1/8	3/16	-	SC5103-4
43132	0375A-1.625	1-5/8	3/4	.375	.374	5/8	1/8	3/16	-	-
43799	-	1-5/8	7/8	.375	.374	1/2	1/8	3/16	-	-
43921	-	1-5/8	7/8	.375	.374	3/4	1/8	3/16	-	-
43891	-	1-5/8	7/8	.375	.374	7/8	1/8	3/16	-	-
43865	-	1-3/4	1	.375	.374	1/2	1/8	3/16	-	-
43134	0375A-1.750	1-3/4	1	.375	.374	5/8	1/8	3/16	-	SC5103-6
43578	-	1-3/4	1	.375	.374	7/8	1/8	3/16	-	-
43135	0375A-1.750-1	1-3/4	1-3/8	.375	.374	5/8	1/8	3/16	-	-
43136	0375A-1.750-1FH	1-3/4	1-3/8	.375	.374	7/8	5/32	3/16	7-9419-008	-
43137	0375A-1.750-2	1-3/4	1-1/8	.375	.374	5/8	1/8	3/16	-	-
43138	0375A-1.750-3	1-3/4	1-3/8	.375	.374	3/4	5/32	3/16	7-9419-004	-
43139	0375A-1.8125	1-13/16	1-1/4	.375	.374	5/8	1/8	3/16	-	SC5103-5
43140	0375A-1.875	1-7/8	7/8	.375	.374	5/8	1/8	3/16	-	SC5103-7
43915	-	2	1-1/4	.375	.374	9/16	1/8	3/16	-	-
43141	0375A-2.000	2	1-1/4	.375	.374	5/8	1/8	3/16	-	SC5103-8
43142	0375A-2.000FH	2	1	.375	.374	7/8	5/32	3/16	7-9419-002	-
43143	0375A-2.000-1	2	1	.375	.374	5/8	1/8	3/16	-	-
43144	0375A-2.000-1FH	2	1-1/2	.375	.374	7/8	5/32	3/16	7-9419-009	-
43146	0375A-2.000-3	2	1	.375	.374	3/4	5/32	3/16	7-9419	-
43147	0375A-2.000-4	2	1-1/2	.375	.374	3/4	5/32	3/16	7-9419-005	-
43148	0375A-2.125	2-1/8	1/4	.375	.374	5/8	1/8	3/16	-	-
43916	-	2-1/8	1-3/8	.375	.374	5/8	1/8	3/16	-	-
43983	-	2-1/8	1-3/8	.375	.374	3/4	1/8	3/16	-	-
43535	-	2	1-3/8	.375	.374	5/8	1/8	3/16	-	-
43149	0375A-2.250FH	2-1/4	1-5/8	.375	.374	7/8	5/32	3/16	7-9419-010	-
43150	0375A-2.250-1	2-1/4	1-1/2	.375	.374	5/8	1/8	3/16	-	SC5103-9
43151	0375A-2.250-2	2-1/4	1-1/4	.375	.374	5/8	1/8	3/16	-	SC5103-10
43152	0375A-2.250-3	2-1/4	1-5/8	.375	.374	5/8	1/8	3/16	-	-
43153	0375A-2.250-4	2-1/4	1-5/8	.375	.374	3/4	5/32	3/16	7-9419-006	-
43154	0375A-2.375	2-3/8	1-1/2	.375	.374	5/8	1/8	3/16	-	-
43155	0375A-2.375FH	2-3/8	1-3/8	.375	.374	7/8	5/32	3/16	7-9419-003	-
43156	0375A-2.375-1	2-3/8	1-3/16	.375	.374	5/8	1/8	3/16	-	-
43157	0375A-2.375-1FH	2-3/8	1-1/2	.375	.374	7/8	5/32	3/16	7-9419-011	-
43158	0375A-2.375-2	2-3/8	5/16	.375	.374	5/8	1/8	3/16	-	-
43159	0375A-2.375-3	2-3/8	1-3/8	.375	.374	3/4	5/32	3/16	7-9419-001	-
43160	0375A-2.375-4	2-3/8	1-1/2	.375	.374	3/4	5/32	3/16	7-9419-007	-
43161	0375A-2.4375	2-7/16	1	.375	.374	5/8	1/8	3/16	-	-
43162	0375A-2.500	2-1/2	1-5/8	.375	.374	5/8	1/8	3/16	-	SC5103-11

continued on page 9

All photos shown actual size.

* Note: Sizes may not be combined to determine quantity price.





America's Largest
Manufacturer of
Precision Grinding
Wheel Adapters.

3/8-20RH THREAD SIZE WHEELSCREWS



43169

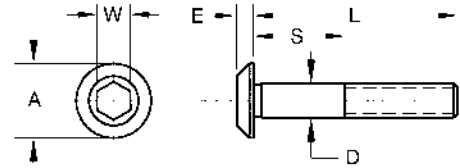

continued from page 8

SOPKO CATALOG NO.	SOPKO PART NO.	L	S	D		A	E	W	HEALD PART NO.	BRYANT PART NO.
				MAX	MIN					
43163	0375A-2.500-1	2-1/2	1-7/8	.375	.374	5/8	1/8	3/16	-	-
43777	-	2-5/8	1-7/8	.375	.374	1/2	1/8	3/16	-	-
43165	0375A-2.625-1	2-5/8	1-7/8	.375	.374	5/8	1/8	3/16	-	-
43610	-	2-3/4	2	.375	.374	5/8	1/8	3/16	-	-
43625	-	2-7/8	2-1/8	.375	.374	5/8	1/8	3/16	-	-
43692	-	2-7/8	2-1/8	.375	.374	3/4	1/8	3/16	-	-
43693	-	2-7/8	2-1/8	.375	.374	7/8	1/8	3/16	-	-
43691	-	2-7/8	2-1/8	.375	.374	1	1/8	3/16	-	-
43169	0375A-3.000	3	1-5/8	.375	.374	5/8	1/8	3/16	-	-
43591	-	3-1/8	2-3/8	.375	.374	5/8	1/8	3/16	-	-
43592	-	3-1/8	2-3/8	.375	.374	3/4	1/8	3/16	-	-
43593	-	3-1/8	2-3/8	.375	.374	7/8	1/8	3/16	-	-
43173	0375A-3.375	3-3/8	1-3/4	.375	.374	5/8	1/8	3/16	-	-
43174	0375A-4.000	4	2	.375	.374	5/8	1/8	3/16	-	-

1/2-20RH THREAD SIZE WHEELSCREWS

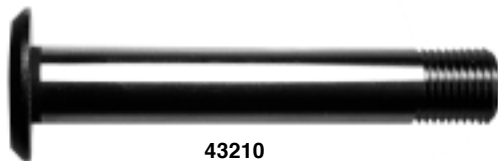

43210

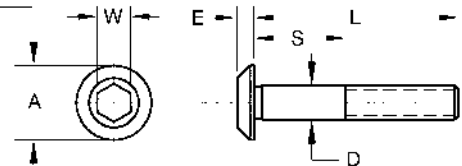

SOPKO CATALOG NO.	SOPKO PART NO.	L	S	D		A	E	W	HEALD PART NO.	BRYANT PART NO.
				MAX	MIN					
43195	0500-1.250FH	1-1/4	3/8	.500	.499	1-1/2	1/8	1/4	7-11253-010	-
43505	-	1-5/8	3/4	.500	.499	1	1/8	1/4	-	-
43844	-	1-3/4	7/8	.500	.499	3/4	1/8	1/4	-	-
43887	-	1-3/4	7/8	.500	.499	1	1/8	1/4	-	-
43629	-	1-3/4	7/8	.500	.499	1-1/4	1/8	1/4	-	-
43563	-	1-7/8	1	.500	.499	7/8	1/8	1/4	-	-
43843	-	1-7/8	1	.500	.499	1	1/8	1/4	-	-
43670	-	1-7/8	1	.500	.499	1-1/4	1/8	1/4	-	-
43199	0500-2.000	2	1-7/16	.500	.499	1	1/8	1/4	-	-
43202	0500-2.000-2	2	3/4	.500	.499	1	1/8	1/4	-	-
43845	-	2	1-1/8	.500	.499	1	1/8	1/4	-	-
43717	-	2	1-1/8	.500	.499	1-1/8	1/8	1/4	-	-
43851	-	2-1/8	1-1/4	.500	.499	3/4	1/8	1/4	-	-
43910	-	2-1/8	1-1/4	.500	.499	1	1/8	1/4	-	-
43784	-	2-1/4	1-3/8	.500	.499	1-5/8	1/8	1/4	-	-
43208	0500-2.500-2	2-1/2	1-3/8	.500	.499	7/8	1/8	1/4	-	-
43760	-	2-3/8	1-1/2	.500	.499	3/4	1/8	1/4	-	-
43562	-	2-3/8	1-1/2	.500	.499	7/8	1/8	1/4	-	-
43561	-	2-3/8	1-1/2	.500	.499	1	1/8	1/4	-	-
43721	-	2-5/8	1-3/4	.500	.499	1-5/8	1/8	1/4	-	-
43775	-	2-7/8	2	.500	.499	3/4	1/8	1/4	-	-
43702	-	2-7/8	2	.500	.499	1	1/8	1/4	-	-
43881	-	2-7/8	2	.500	.499	1-1/8	1/8	1/4	-	-
43701	-	2-7/8	2	.500	.499	1-1/4	1/8	1/4	-	-
43210	0500-3.000	3	2-1/2	.500	.499	1	1/8	1/4	-	-
43212	0500-3.500	3-1/2	2	.500	.499	1	1/8	1/4	-	-

All photos shown actual size.

* Note: Sizes may not be combined to determine quantity price.



CAUTION!

Always Wear Safety Goggles When Grinding.

5/8-18RH THREAD SIZE WHEELSCREWS



America's Largest
Manufacturer of
Precision Grinding
Wheel Adapters.

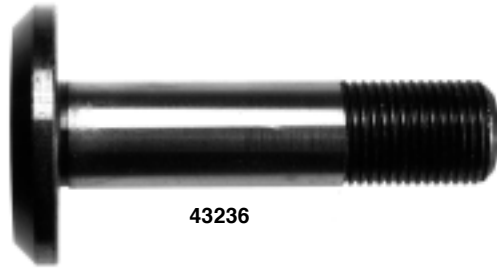

43236

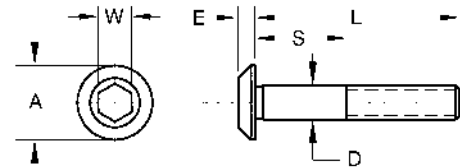

SOPKO CATALOG NO.	SOPKO PART NO.	L	S	D		A	E	W	HEALD PART NO.	BRYANT PART NO.
				MAX	MIN					
43214	0625-1.625	1-5/8	3/4	.625	.624	15/16	1/8	5/16	-	SC5104-8
43215	0625-1.625FH	1-5/8	3/4	.625	.624	1-1/2	1/4	5/16	-	SC5104-1
43948	-	1-11/16	11/16	.625	.624	2	1/4	5/16	-	-
43216	0625-1.750	1-3/4	7/8	.625	.624	15/16	1/8	5/16	-	SC5104-9
43217	0625-1.750FH	1-3/4	7/8	.625	.624	1-1/2	1/4	5/16	-	SC5104-2
43218	0625-1.812	1-13/16	1-5/16	.625	.624	15/16	1/8	5/16	-	-
43977	-	1-7/8	7/8	.625	.624	1	1/8	5/16	-	-
43219	0625-1.875	1-7/8	1	.625	.624	15/16	1/8	5/16	-	SC5104-10
43220	0625-1.875FH	1-7/8	1	.625	.624	1-1/2	1/4	5/16	-	SC5104-3
43643	-	2	1	.625	.624	1	3/16	5/16	-	-
43222	0625-2.000	2	1-1/8	.625	.624	15/16	1/8	5/16	-	SC5104-11
43223	0625-2.000FH	2	1-1/8	.625	.624	1-1/2	1/4	5/16	-	SC5104-4
43225	0625-2.062-1	2-1/16	1-9/16	.625	.624	1	3/16	5/16	7-9420-006	SC5104-21
43226	0625-2.062-2	2-1/16	1-9/16	.625	.624	1-1/8	3/16	5/16	7-9420-010	-
43227	0625-2.062-3	2-1/16	1-9/16	.625	.624	1-1/4	3/16	5/16	7-9420-014	-
43507	-	2-1/8	1-1/8	.625	.624	1	3/16	5/16	-	-
43499	-	2-1/8	1-1/8	.625	.624	1-1/4	3/16	5/16	-	-
43228	0625-2.250	2-1/4	1-3/4	.625	.624	15/16	1/8	5/16	-	-
43229	0625-2.250FH	2-1/4	1-3/8	.625	.624	1-1/2	1/4	5/16	-	SC5104-12
43230	0625-2.250-1	2-1/4	1-3/4	.625	.624	1	3/16	5/16	7-9420-007	-
43231	0625-2.250-2	2-1/4	1-3/4	.625	.624	1-1/8	3/16	5/16	7-9420-011	-
43233	0625-2.250-4	2-1/4	1-3/4	.625	.624	1-1/4	3/16	5/16	7-9420-015	-
43234	0625-2.375	2-3/8	1-7/8	.625	.624	15/16	1/8	5/16	-	-
43637	-	2-1/2	1-1/2	.625	.624	1	1/8	5/16	-	-
43236	0625-2.500FH	2-1/2	1-5/8	.625	.624	1-1/2	1/4	5/16	-	-
43237	0625-2.500-1	2-1/2	1-3/4	.625	.624	15/16	1/8	5/16	-	-
43238	0625-2.500-1FH	2-1/2	1-3/4	.625	.624	1-1/4	3/16	5/16	7-9420-016	-
43240	0625-2.500-3	2-1/2	1-3/8	.625	.624	1	3/16	5/16	7-9420	-
43241	0625-2.500-4	2-1/2	1-3/8	.625	.624	1-1/8	3/16	5/16	7-9420-002	-
43242	0625-2.500-5	2-1/2	1-3/8	.625	.624	1-1/4	3/16	5/16	7-9420-004	-
43637	-	2-1/2	1-1/2	.625	.624	1	3/16	5/16	-	-
43243	0625-2.500-6	2-1/2	1-3/4	.625	.624	1	3/16	5/16	7-9420-008	-
43244	0625-2.500-7	2-1/2	1-3/4	.625	.624	1-1/8	3/16	5/16	7-9420-012	-
43565	-	2-5/8	1-5/8	.625	.624	1	3/16	5/16	-	-
43582	-	2-5/8	1-5/8	.625	.624	1-1/4	3/16	5/16	-	-
43767	-	2-5/8	1-5/8	.625	.624	1-1/2	1/4	5/16	-	-
43245	0625-2.625FH	2-5/8	1-3/4	.625	.624	1-1/2	1/4	5/16	-	SC5104-14
43246	0625-2.750	2-3/4	1-3/8	.625	.624	15/16	1/8	5/16	-	SC5104-5
43247	0625-2.750FH	2-3/4	1-7/8	.625	.624	1-1/2	1/4	5/16	-	SC5104-15
43248	0625-2.750-1	2-3/4	1-3/4	.625	.624	15/16	1/8	5/16	-	-
43250	0625-2.750-3	2-3/4	1-3/4	.625	.624	1-1/8	3/16	5/16	7-9420-013	-
43251	0625-2.750-4	2-3/4	1-3/4	.625	.624	1	3/16	5/16	7-9420-009	-
43252	0625-2.750-5	2-3/4	1-3/4	.625	.624	1-1/4	3/16	5/16	7-9420-017	-
43253	0625-2.875	2-7/8	1-3/4	.625	.624	15/16	1/8	5/16	-	-
43254	0625-2.875-1	2-7/8	1-3/4	.625	.624	1	3/16	5/16	7-9420-001	-
43255	0625-2.875-2	2-7/8	1-3/4	.625	.624	1-1/4	3/16	5/16	7-9420-005	-
43256	0625-2.875-3	2-7/8	1-3/4	.625	.624	1-1/8	3/16	5/16	7-9420-003	-
43566	-	2-7/8	1-7/8	.625	.624	1	3/16	5/16	-	-
43576	-	2-7/8	1-7/8	.625	.624	1-1/8	3/16	5/16	-	-
43583	-	2-7/8	1-7/8	.625	.624	1-1/4	3/16	5/16	-	-
43584	-	3-1/8	2-1/8	.625	.624	1	1/8	5/16	-	-
43769	-	3-1/8	2-1/8	.625	.624	1-1/2	3/16	5/16	-	-
43339	0625-3.250	3-1/4	1-5/8	.625	.624	15/16	1/8	5/16	-	-
43258	0625-3.250-1	3-1/4	1-7/8	.625	.624	15/16	1/8	5/16	-	SC5104-6
43642	-	3-3/8	2-3/8	.625	.624	1	3/16	5/16	-	-
43526	-	3-5/8	2-5/8	.625	.624	1	3/16	5/16	-	-
43878	-	3-5/8	2-5/8	.625	.624	1-1/4	3/16	5/16	-	-
43768	-	3-5/8	2-5/8	.625	.624	1-1/2	3/16	5/16	-	-
43260	0625-3.750	3-3/4	2-3/8	.625	.624	15/16	1/8	5/16	-	SC5104-7
43585	-	4-1/8	3-1/8	.625	.624	1	1/8	5/16	-	-
43594	-	4-3/8	3-3/8	.625	.624	1-1/8	3/16	5/16	-	-
43595	-	4-3/8	3-3/8	.625	.624	1-1/4	3/16	5/16	-	-

7/8-14RH THREAD SIZE WHEELSCREWS



America's Largest
Manufacturer of
Precision Grinding
Wheel Adapters.

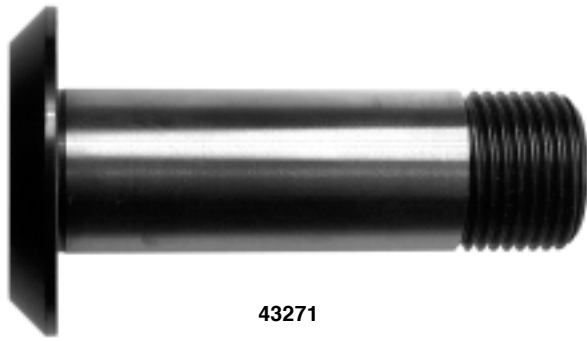

43271

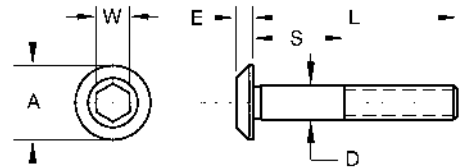

SOPKO CATALOG NO.	SOPKO PART NO.	L	S	D		A	E	W	HEALD PART NO.	BRYANT PART NO.
				MAX	MIN					
43263	0875-1.875	1-7/8	1-1/4	.875	.874	1-1/4	1/4	1/2	-	SC5105-4
43265	0875-2.375	2-3/8	1-1/8	.875	.874	1-1/4	1/4	1/2	-	SC5105-6
43266	0875-2.500	2-1/2	1-7/8	.875	.874	1-1/4	1/4	1/2	-	SC5105-7
43677	-	2-5/8	1-3/8	.875	.874	2	1/4	1/2	-	-
43635	-	2-3/4	1-1/2	.875	.874	2	1/4	1/2	-	-
43267	0875-2.750	2-3/4	2-1/8	.875	.874	1-1/4	1/4	1/2	-	SC5105-8
43268	0875-2.750FH	2-3/4	2-1/8	.875	.874	1-5/8	1/4	1/2	7-9421-012	-
43269	0875-2.750-1	2-3/4	2-1/8	.875	.874	1-1/2	1/4	1/2	7-9421-010	-
43270	0875-2.750-1FH	2-3/4	2-1/8	.875	.874	2	1/4	1/2	7-9421-016	-
43271	0875-2.750-2	2-3/4	2-1/8	.875	.874	1-3/4	1/4	1/2	7-9421-014	-
43272	0875-2.750-2FH	2-3/4	2-1/8	.875	.874	2-3/8	1/4	1/2	7-9421-018	-
43273	0875-2.875	2-7/8	1-1/2	.875	.874	1-1/4	1/4	1/2	-	SC5105-9
43274	0875-2.875FH	2-7/8	1-1/2	.875	.874	1-5/8	1/4	1/2	7-9421-002	SC5105-9A
43275	0875-2.875-1	2-7/8	1-1/2	.875	.874	1-1/2	1/4	1/2	7-9421	-
43276	0875-2.875-1FH	2-7/8	1-1/2	.875	.874	2	1/4	1/2	7-9421-006	-
43277	0875-2.875-2	2-7/8	1-1/2	.875	.874	1-3/4	1/4	1/2	7-9421-004	-
43278	0875-2.875-2FH	2-7/8	1-7/16	.875	.874	2-3/8	1/4	1/2	-	-
43279	0875-2.875-3FH	2-7/8	1-1/2	.875	.874	2-3/8	1/4	1/2	7-9421-008	-
43280	0875-3.000	3	2-1/8	.875	.874	1-1/4	1/4	1/2	-	SC5105-10
43281	0875-3.000FH	3	2-1/8	.875	.874	1-5/8	1/4	1/2	7-9421-013	-
43282	0875-3.000-1	3	2-1/8	.875	.874	1-3/4	1/4	1/2	7-9421-015	-
43283	0875-3.000-2	3	2-1/8	.875	.874	1-1/2	1/4	1/2	7-9421-011	-
43284	0875-3.000-2FH	3	2-1/8	.875	.874	2	1/4	1/2	7-9421-017	-
43285	0875-3.000-3FH	3	2-1/8	.875	.874	2-3/8	1/4	1/2	7-9421-019	-
43286	0875-3.125	3-1/8	2	.875	.874	1-1/4	1/4	1/2	-	-
43722	-	3-1/8	1-7/8	.875	.874	2-3/8	1/4	1/2	-	-
43287	0875-3.250	3-1/4	1-1/2	.875	.874	1-1/4	1/4	1/2	-	SC5105-1
43288	0875-3.375	3-3/8	2	.875	.874	1-1/4	1/4	1/2	-	SC5105-1A
43289	0875-3.375FH	3-3/8	2-1/8	.875	.874	1-1/2	1/4	1/2	-	SC5105-1B
43554	-	3-3/8	2-1/8	.875	.874	1-5/8	1/4	1/2	-	-
43553	-	3-3/8	2-1/8	.875	.874	2	1/4	1/2	-	-
43290	0875-3.375-1	3-3/8	2	.875	.874	1-1/2	1/4	1/2	7-9421-001	SC5105-1C
43555	-	3-3/8	2-1/8	.875	.874	1-3/4	1/4	1/2	-	-
43291	0875-3.375-1FH	3-3/8	2-1/4	.875	.874	1-1/2	1/4	1/2	-	SC5105-1D
43292	0875-3.375-2FH	3-3/8	2	.875	.874	1-5/8	1/4	1/2	7-9421-003	-
43293	0875-3.375-3FH	3-3/8	2	.875	.874	1-3/4	1/4	1/2	7-9421-005	-
43294	0875-3.375-4FH	3-3/8	2	.875	.874	2	1/4	1/2	7-9421-007	-
43295	0875-3.375-5FH	3-3/8	2	.875	.874	2-3/8	1/4	1/2	7-9421-009	-
43552	-	3-5/8	2-3/8	.875	.874	1-1/2	1/4	1/2	-	-
43714	-	3-7/8	2-5/8	.875	.874	2	1/4	1/2	-	-
43296	0875-4.000	4	2	.875	.874	1-1/4	1/4	1/2	-	SC5105-2
43774	-	4-1/8	2-7/8	.875	.874	1-1/4	1/4	1/2	-	-
43619	-	4-1/8	2-7/8	.875	.874	1-1/2	1/4	1/2	-	-
43599	-	4-1/8	2-7/8	.875	.874	2	1/4	1/2	-	SC5105-2A
43298	0875-4.500	4-1/2	2-5/8	.875	.874	1-1/4	1/4	1/2	-	SC5105-3
43920	-	4-5/8	3-3/8	.875	.874	2	1/4	1/2	-	-
43720	-	4-3/4	3-5/8	.875	.874	2	1/4	1/2	-	-
43922	-	4-7/8	3-5/8	.875	.874	1-1/4	1/4	1/2	-	-
43301	0875-6.000	6	3	.875	.874	1-1/4	1/4	1/2	-	SC5105-3C

All photos shown actual size.

* Note: Sizes may not be combined to determine quantity price.



CAUTION!

Always Wear Safety Goggles When Grinding.

Left Hand Thread Sizes



America's Largest
Manufacturer of
Precision Grinding
Wheel Adapters.



43316

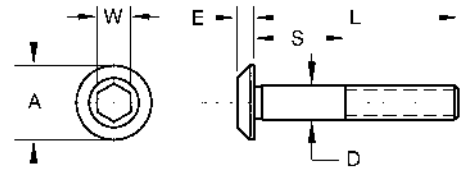

SOPKO CATALOG NO.	SOPKO PART NO.	L	S	D		A	E	W	HEALD PART NO.	BRYANT PART NO.
				MAX	MIN					

5-40LH THREAD SIZE

43302	LH125-1.062	1-1/16	1/2	.125	.124	1/4	1/16	5/64	-	-
43303	LH125-1.250-1	1-1/4	1/2	.125	.124	1/4	1/16	5/64	-	-
43304	LH125-1.250-2	1-1/4	3/4	.125	.124	1/4	1/16	5/64	-	-
43305	LH125-1.500	1-1/2	1	.125	.124	1/4	1/16	5/64	-	-

8-32LH THREAD SIZE

43306	LH1875-1.250	1-1/4	5/8	.1875	.1874	3/8	1/8	5/64	-	-
43307	LH1875-1.375	1-3/8	3/4	.1875	.1874	3/8	1/8	5/64	-	-
43308	LH1875-1.500-1	1-1/2	3/4	.1875	.1874	3/8	1/8	5/64	-	-
43309	LH1875-1.750	1-3/4	1-1/8	.1875	.1874	3/8	1/8	5/64	-	-

10-32LH THREAD SIZE

43694	-	15/16	3/8	.1875	.1874	3/8	1/8	3/32	-	-
43695	-	1-1/8	9/16	.1875	.1874	3/8	1/8	3/32	-	-
43696	-	1-3/8	13/16	.1875	.1874	3/8	1/8	3/32	-	-
43310	LH1032-1.500-2	1-1/2	7/8	.1875	.1874	3/8	1/8	3/32	-	-

1/4-20LH THREAD SIZE

43311	LH250-0.625	5/8	0	.250	.249	7/16	1/8	1/8	-	-
43312	LH250-0.875	7/8	0	.250	.249	7/16	1/8	1/8	-	-
43914	-	1	3/8	.250	.249	7/16	1/8	1/8	-	-
43314	LH250-1.062	1-1/16	9/16	.250	.249	7/16	1/8	1/8	-	-
43841	-	1-1/8	1/2	.250	.249	3/8	1/8	1/8	-	-
43315	LH250-1.250	1-1/4	9/16	.250	.249	7/16	1/8	1/8	-	-
43860	-	1-1/4	5/8	.250	.249	3/8	1/8	1/8	-	-
43842	-	1-3/8	3/4	.250	.249	3/8	1/8	1/8	-	-
43316	LH250-1.375	1-3/8	3/4	.250	.249	7/16	1/8	1/8	-	-
43684	-	1-3/8	3/4	.250	.249	1	1/8	1/8	-	-
43317	LH250-1.500	1-1/2	3/4	.250	.249	7/16	1/8	1/8	-	-
43685	-	1-1/2	7/8	.250	.249	1	1/8	1/8	-	-
43318	LH250-1.750	1-3/4	7/8	.250	.249	7/16	1/8	1/8	-	-
43862	-	1-7/8	1-1/4	.250	.249	7/16	1/8	1/8	-	-
43320	LH250-2.250	2-1/4	1-3/8	.250	.249	7/16	1/8	1/8	-	-

continued on page 13

All photos shown actual size.

* Note: Sizes may not be combined to determine quantity price.

CAUTION!
Always Wear Safety Goggles When Grinding.

Left Hand Thread Sizes



America's Largest
Manufacturer of
Precision Grinding
Wheel Adapters.



43325

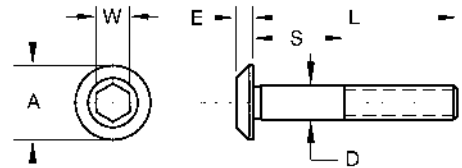

continued from page 12

SOPKO CATALOG NO.	SOPKO PART NO.	L	S	D		A	E	W	HEALD PART NO.	BRYANT PART NO.
				MAX	MIN					
3/8-16LH THREAD SIZE										
43864	-	1-1/4	1/2	.375	.374	5/8	1/8	3/16	-	-
43654	-	1-1/2	3/4	.375	.374	5/8	1/8	3/16	-	-
43853	-	1-5/8	7/8	.375	.374	1/2	1/8	3/16	-	-
43600	-	1-5/8	7/8	.375	.374	5/8	1/8	3/16	-	-
43518	-	1-7/8	1-1/8	.375	.374	5/8	1/8	3/16	-	-
43323	LH375B-2.000	2	1-3/8	.375	.374	5/8	1/8	3/16	-	-
43324	LH375B-2.375	2-3/8	1-3/16	.375	.374	5/8	1/8	3/16	-	-
43325	LH375B-2.375FH	2-3/8	1-3/16	.375	.374	3/4	1/8	3/16	-	-
43326	LH375B-3.000	3	2	.375	.374	5/8	1/8	3/16	-	-

3/8-20LH THREAD SIZE										
43689	-	1-5/8	7/8	.375	.374	7/8	1/8	3/16	-	-

1/2-20LH THREAD SIZE										
43682	-	1-5/8	3/4	.500	.499	1	1/8	1/4	-	-
43683	-	1-3/4	7/8	.500	.499	1	1/8	1/4	-	-
43678	-	2	1-1/8	.500	.499	1	1/8	1/4	-	-
43601	-	2-1/4	1-3/8	.500	.499	1	1/8	1/4	-	-
43567	-	2-3/8	1-1/2	.500	.499	1	1/8	1/4	-	-
43568	-	2-3/8	1-1/2	.500	.499	1-1/4	1/8	1/4	-	-
43900	-	2-5/8	1-3/4	.500	.499	1	1/8	1/4	-	-
43569	-	2-7/8	2	.500	.499	1	1/8	1/4	-	-
43679	-	3-1/8	2-1/4	.500	.499	1-1/4	1/8	1/4	-	-
43334	LH500-3.250-3FH	3-1/4	2	.500	.499	1-1/4	1/8	1/4	-	-
43335	LH500-3.500	3-1/2	2	.500	.499	1	1/8	1/4	-	-

5/8-18LH THREAD SIZE										
43780	-	2-3/8	1-3/8	.625	.624	1	1/8	1/4	-	-
43781	-	3-1/8	2-1/8	.625	.624	1	1/8	1/4	-	-

All photos shown actual size.

* Note: Sizes may not be combined to determine quantity price.



CAUTION!

Always Wear Safety Goggles When Grinding.

We Offer Solutions...

If you need a SPECIAL WHEELSCREW that can't be found in our selection of standard products, we can make it for you!

We've built a reputation over the past 50 years by providing customers with top quality specialty wheelscrews. Our experienced staff can work from rough drawings or your finished prints to create a product that will perform safely in its intended application.

Give us an opportunity to prepare a quote for you. Inquiries or requests for detailed information about our capabilities should be directed to:

**Mike Lazanich, Sales Engineer
Fax (216) 289-1888**

We Manufacture Quills Too!



- Bryant
- Collet Chucks
- Ex-Cell-O
- Fischer
- Gamifior
- GMN/Whitton

- Heald
- Heavy Metal / No Chat
- Jarno Taper
- Metric
- Okamoto
- Okuma

- Parker
- Pencil Chucks
- Pope
- Setco
- Straight Shank
- Taper Shank

Before you begin, please photocopy this page and use it as your order form.

FAX/MAIL ORDER FORM 1-216-289-1888



America's Largest
Manufacturer of
Precision Grinding
Wheel Adapters.

SHIPPING AND BILLING INFORMATION

SHIP TO:

NAME _____

COMPANY _____

ADDRESS _____

CITY _____ STATE _____

ZIP _____ - _____

PURCHASE ORDER NO _____

PHONE (____) _____ FAX (____) _____

UPS GROUND

RPS GROUND

OTHER

BILL TO:

NAME _____

COMPANY _____

ADDRESS _____

CITY _____ STATE _____

ZIP _____ - _____

PURCHASE ORDER NO _____

PHONE (____) _____ FAX (____) _____

PAYMENT INFORMATION

NEW ACCOUNT: Submit name, address, and phone number of bank, and three credit references.

CREDIT CARD:

CORPORATE

PERSONAL



NAME _____

ADDRESS _____

CITY _____ STATE _____ ZIP _____

PHONE (____) _____ FAX (____) _____

SIGNATURE _____ EXPIRATION DATE

CREDIT CARD NUMBER

LIST PRODUCTS TO BE SHIPPED

CATALOG NO.	QTY.	PART NO. / DESCRIPTION	PRICE	TOTAL
SUBTOTAL				

Mail completed order form to: **26500 Lakeland Blvd. Cleveland, OH 44132-2692**

Fax completed order form 24 hours a day to: **1-216-289-1888**

If you prefer to call your order in or if you have questions, **phone 216-289-1400 8:00 A.M. to 5:00 P.M. ET.**

Orders received by 2:30 P.M. ET shipped same day.

Thank You For Your Order!

Ask For These Other Sopko Publications



Wheel Adapters

- Standard Taper
- Cincinnati Taper
- Reversible
- Balancing
- Specials

Catalog No.
49956



Quills

- Heald Straight
- Heald Taper
- Jarno Taper
- Okuma
- GMN
- Bryant
- Fischer

Catalog No.
49946
49952
49948
49893
49699
49894
49700



Pulleys

- Poly-V
- Flat Belt
- Cross Grooved
- Motor
- Specials

Catalog No.
49897



Belts

- Spindle Belts
- V-belts
- Timing
- Industrial Belt Products

Catalog No.
49890



Precision Spindle Rebuilding

- All Manufacturers
- Experienced Staff
- Fast Turnaround
- Quality Workmanship
- Rebuilt/Used Available

Catalog No.
49899

Wm. Sopko & Sons Co., Inc. • 26500 Lakeland Blvd. • Cleveland, Ohio 44132-2692 U.S.A.

(216) 289-1400 • Fax: (216) 289-1888

Visit Our Website: <http://www.wmsopko.com>



America's Largest Manufacturer and Distributor of Precision Grinding Wheel Adapters and Grinding Spindle Accessories



Member of:

National Tooling &
Machining Association



Member



Society of
Manufacturing
Engineers



DISTRIBUTED BY:



SOPKO

Wm. Sopko & Sons Co., Inc. • 26500 Lakeland Blvd. • Cleveland, Ohio 44132-2692 U.S.A.

(216) 289-1400 • Fax: (216) 289-1888

Visit Our Website: <http://www.wmsopko.com>